



EN

COXO®

www.coxotec.com



COXO Medical Instrument Co.,Ltd

BLDG 4, District A, Guangdong New Light Source Industrial Base, South of Luocun Avenue, Nanhai District, Foshan, 528226 Guangdong, China



Wellkang Ltd

Suite B, 29 Harley Street, London W1G9QR, United Kingdom

Endo Motor
C-SMART
Mini **AP**

User Manual

CE 0197

Introduction

Thank you for purchasing the instrument.

For optimum safety and performance, read this manual thoroughly before using the instrument and pay close attention to warnings and notes.

Keep this manual in a handy place for quick and easy reference.

Notice

The trademarks mentioned in this manual are the property of their legally registered companies.

The file manufacturers, file system names and the file names referred to in this manual are for identification purposes only and are the property of their respective manufacturer or brands.

Fig. A Components and Accessories

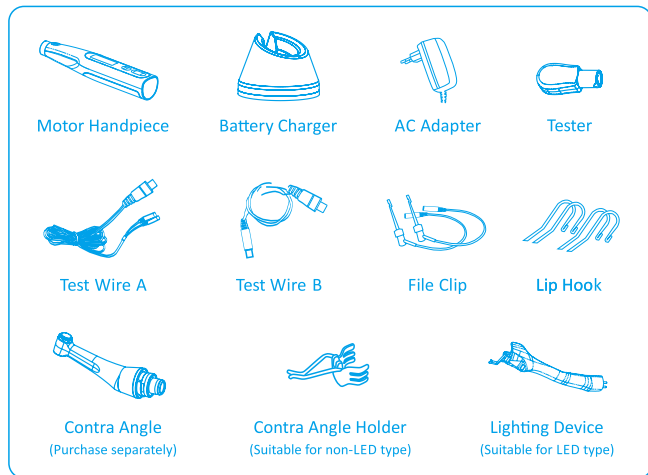
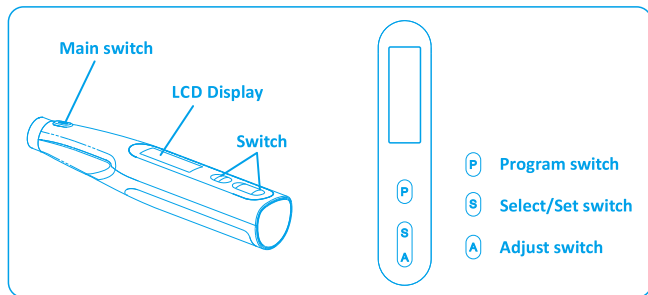

Fig. B Handpiece and Switch



Recommended separation distances between portable and mobile RF communications equipment and the instrument.			
The instrument is intended for use in an electromagnetic environment in which radiated RF disturbances are controlled. The customer or the user of the instrument can help prevent electromagnetic interference by maintaining a minimum distance between portable and mobile RF communications equipment (transmitters) and the instrument as recommended below, according to the maximum output power of the communications equipment.			
Rated maximum output power of transmitter (W)	Separation distance according to frequency of transmitter		
	150 kHz to 80 MHz $d=1.2 \times P^{1/2}$	80 MHz to 800 MHz $d=1.2 \times P^{1/2}$	80 MHz to 800 MHz $d=2.3 \times P^{1/2}$
0.01	0.12	0.12	0.23
0.1	0.38	0.38	0.73
1	1.2	1.2	2.3
10	3.8	3.8	7.3
100	12	12	23

For transmitters rated at a maximum output power not listed above, the recommended separation distance d in meters (m) can be estimated using the equation applicable to the frequency of the transmitter, where P is the maximum output power rating of the transmitter in watts (W) according to the transmitter manufacturer.

NOTE 1: At 80 MHz and 800 MHz, the separation distance for the higher frequency range applies.

NOTE 2: These guidelines may not apply in all situations. Electromagnetic propagation is affected by absorption and reflection from structures, objects and people.

NOTE 1: At 80 MHz and 800 MHz, the higher frequency range applies.
 NOTE 2: These guidelines may not apply in all situations. Electromagnetic propagation is affected by absorption and reflection from structures, objects and people.

a Field strengths from fixed transmitters, such as base stations for radio (cellular/cordless) telephones and land mobile radios, amateur radio, AM and FM radio broadcast and TV broadcast cannot be predicted theoretically with accuracy. To assess the electromagnetic environment due to fixed RF transmitters, an electromagnetic site survey should be considered. If the measured field strength in the location in which the instrument is used exceeds the applicable RF compliance level above, the instrument should be observed to verify normal operation. If abnormal performance is observed, additional measures may be necessary, such as re-orienting or relocating the instrument.

b Over the frequency range 150 kHz to 80 MHz, field strengths should be less than 3 V/m.

Fig. C Contra Angle & File connection

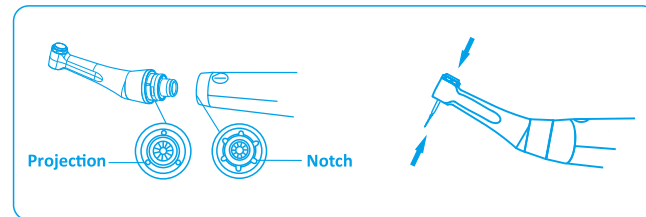

Fig. D Accessory Connection

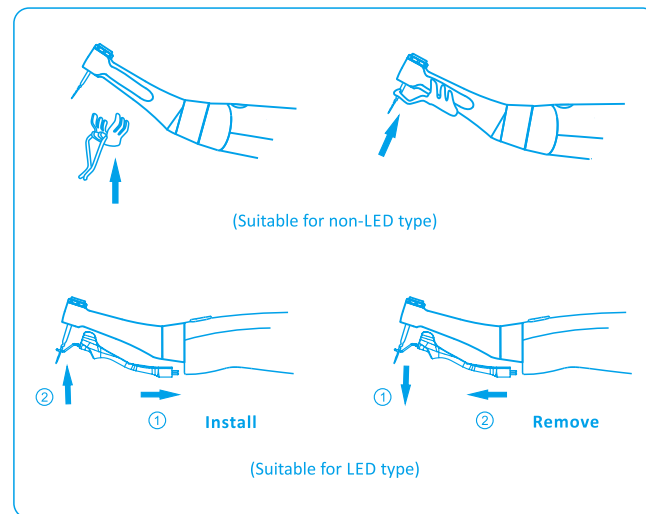

Fig. E Apex Locator Mode

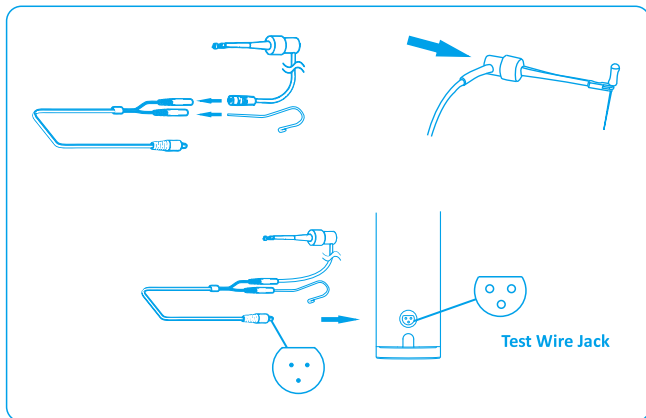
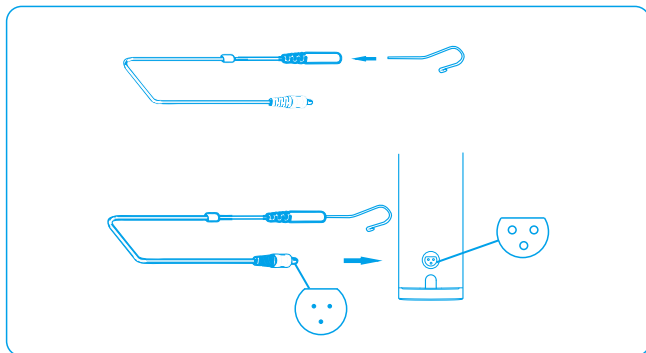



Fig. F Multi-function Mode



Guidance and manufacture's declaration – electromagnetic immunity			
The instrument is intended for use in the electromagnetic environment specified below. The customer or the user of instrument should assure that it is used in such an environment.			
Immunity test	IEC 60601 test level	Compliance level	Electromagnetic environment - guidance
Conducted RF IEC 61000-4-6	3 Vrms 150 kHz to 80 MHz 6 Vrms in ISM ban 3 V/m 80 MHz to 2.7 GHz	3 Vrms 150 kHz to 80 MHz 6 Vrms in ISM ban 3 V/m 80 MHz to 2.7 GHz	Portable and mobile RF communications equipment should be used no closer to any part of the instrument, including cables, than the recommended separation distance calculated from the equation applicable to the frequency of the transmitter. Recommended separation distance $d=1.2xP^{1/2}$ $d=1.2xP^{1/2}$ 80 MHz to 800 MHz $d=1.2xP^{1/2}$ 800 MHz to 2.5 GHz where P is the maximum output power rating of the transmitter in watts (W) according to the transmitter manufacturer and d is the recommended separation distance in meters (m). Field strengths from fixed RF transmitters, as determined by an electromagnetic site survey, ³ should be less than the compliance level in each frequency range. ³ Interference may occur in the vicinity of equipment marked with the following symbol: 
Radiated RF IEC 61000-4-3	385MHz- 5785MHz Test specifications for ENCLOSUREPORT IMMUNITY to RF wireless communication equipment (Refer to table 9 of IEC 60601-1-2:2014)	385MHz- 5785MHz Test specifications for ENCLOSUREPORT IMMUNITY to RF wireless communication equipment (Refer to table 9 of IEC 60601-1-2:2014)	

Guidance and manufacture's declaration – electromagnetic immunity			
The instrument is intended for use in the electromagnetic environment specified below. The customer or the user of instrument should assure that it is used in such an environment.			
Immunity test	IEC 60601 test level	Compliance level	Electromagnetic environment - guidance
Electrostatic discharge (ESD) IEC 61000-4-2	±8 kV contact ±4 kV, ±8kV,±15 kV air	±8 kV contact ±4 kV, ±8kV,±15 kV air	Floors should be wood, concrete or ceramic tile. If floor are covered with synthetic material, the relative humidity should be at least 30%.
Electrical fast transient/burst IEC 61000-4-4	±2kV for power supply lines ±1 kV for input/output lines	±2kV for power supply lines ±1 kV for input/output lines	Mains power quality should be that of atypical commercial or hospital environment.
Surge IEC 61000-4-5	±0.5 kV & ±1 kV differential mode ±0.5 kV, ±1 kV & ±2 kV common mode	±0.5 kV & ±1 kV differential mode ±0.5 kV, ±1 kV & ±2 kV common mode	Mains power quality should be that of a typical commercial or hospital environment.
Voltage dips, short interruptions and voltage variations on power supply input lines IEC 61000-4-11	100 % U_T (100% dip in U_T .) for 0.5 cycle 100 % U_T (100% dip in U_T .) for 1 cycle 30 % U_T (70% dip in U_T .) for 25/30 cycles 100 % U_T (100% dip in U_T .) for 250/300 cycle	100 % U_T (100% dip in U_T .) for 0.5 cycle 100 % U_T (100% dip in U_T .) for 1 cycle 30 % U_T (70% dip in U_T .) for 25/30 cycles 100 % U_T (100% dip in U_T .) for 250/300 cycle	Mains power quality should be that of a typical commercial or hospital environment. If the user of the model instrument requires continued operation during power mains interruptions, it is recommended that the instrument be powered from a unit eruptible power supply or a battery.
Power frequency (50/60 Hz) magnetic field IEC 61000-4-8	3 A/m	3 A/m	Power frequency magnetic fields should be at levels characteristic of a typical location in a typical commercial or hospital environment.
NOTE: U_T is the a.c. mains voltage prior to application of the test level.			

Fig. G Charging

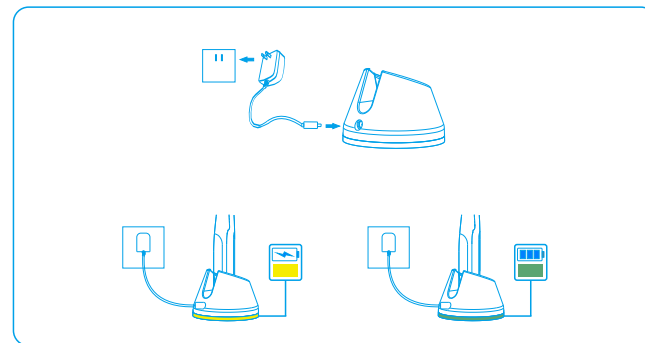

Fig. H Replace the battery

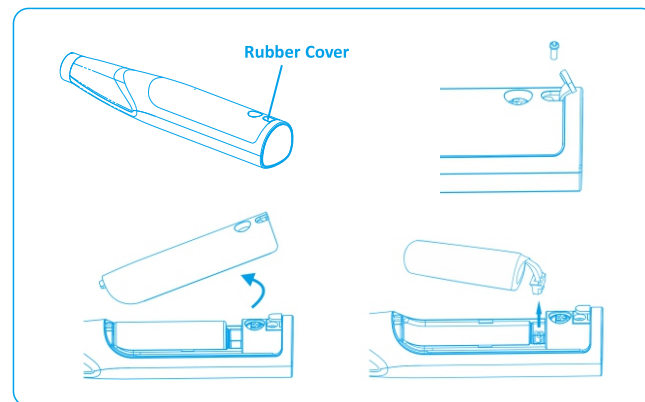

Table of Contents

1. Attention	1
1.1 Attention Customers	1
1.2 Prevent Accidents	1
1.3 Disclaimer	3
1.4 In Case of Accident	3
1.5 User Qualifications	3
1.6 Intended Use	4
2. Usage	5
2.1 Operation and Storage Environments	5
2.2 Operation Modes	5
2.3 Power On/Off	5
2.4 Endo Motor Mode	6
2.5 Apex Locator Mode	14
2.6 Multi-function Mode	19
3. EMR	21
4. Operation Check	23
4.1 Check with Tester	23
4.2 Check Canal Measurement Function	23
5. Battery and Charging	25
5.1 Battery Power	25
5.2 Battery Charging	25
5.3 Replacement Battery	27

13. Guidance and manufacturer's declaration--EMC:

This product needs special precautions regarding EMC and needs to be installed and put into service according to the EMC information provided, and this instrument can be affected by portable and mobile RF communications equipment.



Caution:

Do not use a mobile phone or other devices that emit electromagnetic fields, near the instrument. This may result in incorrect operation of the instrument.

This instrument has been thoroughly tested and inspected to assure proper performance and operation!

This instrument should not be used adjacent to or stacked with other instrument and that if adjacent or stacked use is necessary, this instrument should be observed to verify normal operation in the configuration in which it will be used.

Guidance and manufacture's declaration – electromagnetic emission		
The instrument is intended for use in the electromagnetic environment specified below. The customer or the user of the instrument should assure that it is used in such an environment.		
Emission test	Compliance	Electromagnetic environment – guidance
RF emissions CISPR 11	Group 1	The instrument use RF energy only for its internal function. Therefore, its RF emissions are very low and are not likely to cause any interference in nearby electronic equipment.
RF emission CISPR 11	Class B	The instrument is suitable for use in all establishments, including domestic establishments directly connected to the public low-voltage power supply network with specific requirement.
Harmonic emissions IEC 61000-3-2	Class A	
Voltage fluctuations/ flicker emissions IEC 61000-3-3	Complies	

11. Guarantee

Product and technical services are in charge of our company, the technical department will provide technical support for you when there are technical problems.

The motor handpiece (contra angle and battery are not included) and battery charger are guaranteed for 24 months from the date of purchase.

The contra angle is guaranteed for 12 months from the date of purchase.

The accessories are guaranteed for 6 months from the date of purchase.

The guarantee is valid for normal usage conditions. Any modification or accidental damage will render the guarantee void.

12. Disposal of Medical Devices



In accordance with the principles, standards and requirement of the country(region) in which you are located, dispose of the old electrical equipment. Ensure that pollution are not produced in the process of waste disposal.

6. Calibration and Settings	28
6.1 Enter Setting Mode	28
6.2 Calibration	28
6.3 Set Dominant Hand	29
6.4 Reset Memories to Original Default Settings	30
7. Cleaning, Disinfection and Sterilization	31
8. Troubleshooting	36
9. Technical Specifications	37
10. Symbols	38
11. Guarantee	39
12. Disposal of Medical Devices	39
13. EMC	40

1. Attention

1.1 Attention Customers

Do not fail to receive clear instructions concerning the various ways to use this instrument as described in this accompanying Operation Instructions.

1.2 Prevent Accidents

Most operation and maintenance problems result from insufficient attention being paid to basic safety precautions and not being able to foresee the possibilities of accidents.

Problems and accidents are best avoided by foreseeing the possibility of danger and operating the instrument in accordance with the manufacturer's recommendations.

First, thoroughly read all precautions and instructions pertaining to safety and accident prevention; then, operate the instrument with the utmost caution to prevent either damaging the instrument itself or causing bodily injury.

 **WARNING:**

This alerts the user of possibility of extremely serious injury or complete destruction of the instrument as well as other property damage including the possibility of fire.























 **CAUTION:**

This alerts the user of possibility of minor or moderate injury or damage to the instrument

 **NOTE:**

Informs the user of important points concerning operation or the risk of instrument damage.

10. Symbols

	Warning		Note
	Caution		Lot number
	Manufacturer		Serial number
	Temperature limit		Avoid the sun
	Type B applied part		Keep dry
	CE marked product		Atmospheric pressure limit
	Humidity limit		Fragile
	Vertical up		Class II product
	Direct current		European Union agent
	Thermo-Disinfector		Autoclave
	Special disposal of waste electrical and electronic equipment (Directive2002/96/EEC)		Refer to the operation manual

9. Technical Specifications

Classification	Safety according to IEC 60601-1, IEC 60601-1-2 European Directive 93/42/EEC IIa
Degree of Protection (IEC 60529)	IPX0

Motor Handpiece	
Free running speed	150 ~ 600 rpm
Rated Torque	min. 0.6 N.cm
Degree of Protection against Electric Shock	Type B applied part
Battery	Lithium ion battery (DC 3.7V)

Battery Charger	
Rated Input Voltage	DC 10V
Rated Input Current	1.5 A

AC Adapter	
Rated Input Voltage	AC 100 - 240 V
Rated Input Frequency	50-60 Hz
Classification of Protection against Electric Shock	Class II

Do not use this instrument for anything other than its specified dental treatment purpose.

 **WARNING**

No modification of this instrument is allowed.

 **PROHIBITION**

Do not use this instrument on patients who have implanted pacemakers or defibrillators.

 **IMPORTANT PRECAUTIONS**

These caution remarks are especially critical for safe operation and use. Do not use the wireless transmission devices listed below in the examination area:

- a) Cell phone terminals.
 - b) Wireless transmitting devices such as ham radios, walkie-talkies, and transceivers.
 - c) Personal Handy-phone System.
 - d) Routers for intra-building paging systems, wireless LAN, cordless analogue telephones, and other electric wireless devices.
- This instrument could be adversely affected by the electromagnetic radiation produced by electric scalpels, illumination devices etc. that are being used nearby.
 - Do not perform maintenance while using the instrument for treatment.

1.3 Disclaimer

Manufacturer will not be responsible for accidents, instrument damage, or bodily injury resulting from:

- Repairs made by personnel not authorized by manufacturer.
- Any changes, modifications, or alterations of its products.
- The use of products or instrument made by other manufacturers, except for those procured by manufacturer.
- Maintenance or repairs using parts or components other than those specified by manufacturer and other than in their original condition.
- Operating the instrument in ways other than the operating procedures described in this manual or resulting from the safety precautions and warnings in this manual not being observed.
- Workplace conditions and environment or installation conditions which do not conform to those stated in this manual such as improper electrical power supply.
- Fires, earthquakes, floods, lightning, natural disasters, or acts of God.

1.4 In Case of Accident

If an accident occurs, the instrument must not be used until repairs have been completed by a qualified and trained technician authorized by the manufacturer.

1.5 User Qualifications

Intended Operator Profile

- Qualification:** Legally qualified person such as dentists for endodontic instrument operation (it may differ among countries).
- Education and Knowledge:** It is assumed the user is thoroughly familiar with root canal measuring and treatment including the prevention of cross contamination.

8. Troubleshooting

Problem	Cause	Solution
Cannot turn on the power	The battery is low	Please charge in time
	Battery failure	Replace the battery
Cannot charge the battery	The adapter is not reliably connected	Check that the adapter connection is reliable
	Battery failure	Replacement battery
The battery is running out quickly	The charging time for the battery is too short	Charging time for more than 5 hours
	Battery aging	Replacement battery
Apex locator imprecise/ not sensitive	Test wire connection unreliable	Reconnect the test wire or you can contact the file clip to lip hook directly to check the connection status
	The test wire has an open circuit or a short circuit	Replace test wire
	The root canal is in poor condition	Refer to chapter 3
Cannot start the motor/ motor does not work	Low voltage protection	Please charge in time
	Contra angle stuck	Clean or replace the contra angle
When the motor is running, the torque value is high	Contra angle wear, resistance becomes larger	Enter the setup mode and run the calibration procedure. If the calibration fails, replace the contra angle



CAUTION:

Keep the accessories in a dry, dust-free environment after sterilization.

7.10 Storage

Store the sterilizing equipment in a dry, clean and dust-free environment at a suitable temperature of 5 ° C to 40 ° C.

- c) Language Understanding: English (Intended for professional use as described above)
- d) Experience: Experienced person with operating endodontic instrument

1.6 Intended Use

The instrument is the supplementary root-canal treatment instrument which can assist the dentists to shape more standard root-canal in the process of root-canal treatment based on the micro-electronic control technology. This instrument contributes to alleviate the dentist's working intensity.

This instrument must only be used in hospital environment, clinics or dental offices by qualified dental personnel .

2. Usage

2.1 Operation and Storage Environments

Operating Temperature: +5°C to +40 °C

Humidity: 20% to 80% (without condensation)

Atmospheric Pressure: 86 kPa to 106 kPa

Transport and Storage Temperature: -10 °C to +55 °C

Humidity: ≤ 93% (without condensation)

Atmospheric pressure: 50 kPa to 106 kPa

* Do not expose the instrument to direct sunlight for an extended period of time.

* If the instrument has not been used for some time, make sure it works properly before using it again.

* Always remove the battery prior to storing or shipping the instrument.

(Refer to chapter 5.3)

2.2 Operation Modes

The instrument has 3 modes:

Endo motor: Prepare the root canal, without apex locator function.

Apex Locator: Measure the length of the root canal, without motor function.

Multi-function: Measuring the length while root canal preparation.

2.3 Power On/Off

Hold down  to turn power on/off.

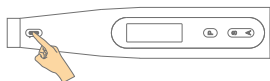

7.6 Drying

Manual drying: Removing any liquid residue with a lint-free cotton cloth, and then blow dry with compressed air (1-2 Bar).

Automatic drying: Refer to chapter 7.5.6)

7.7 Inspection and Maintenance

After cleaning and disinfection, visually inspect the Lip Hook, File Clip and Contra Angle Holder. If no visible contaminants are found, it means that the Lip Hook, File Clip and Contra Angle Holder have been cleaned.

If damage is found by visual inspection, stop using it and purchase damaged parts from the manufacturer or dealer.

7.8 Package

Immediately after drying, put the Lip Hook, File Clip, Contra Angle Holder/Lighting device and Contra Angle into the steam sterilization bag for sealed packaging.



CAUTION:

Steam sterilization bag should comply with ISO 11607-1 and must be sealed with a sealing machine.

7.9 Sterilization

Use a high pressure steam sterilizer in accordance with ISO 17665-1 for sterilization.

- Sterilization parts: The Lip Hook, File Clip, Contra Angle Holder/Lighting device and Contra Angle
- Sterilization method: Autoclave
- Sterilization conditions: 134 °C for not less than 5 minutes

7.5 Automatic Cleaning and Disinfection



It is recommended to use a washer-disinfector to clean and disinfect the Lip Hook, File Clip and Contra Angle Holder.

Put the Lip Hook, File Clip and Contra Angle Holder on the tray of the washer-disinfector, select the "surgical instrument", and start the automatic cleaning

Cleaning and disinfection procedure:

- Pre-cleaning: Pre-clean with tap water less than 40 ° C for 4 minutes
- Cleaning: Immerse and wash with a multi-enzyme cleaner for 6 minutes at 55 ° C
- Rinse stage I: Flush with tap water less than 40 ° C for 1 minute
- Rinse stage II: Flush with tap water less than 40 ° C for 1 minute
- Disinfection: The temperature is 80 ° C and the action time is 10 min
- Drying: The temperature is 100 ° C and the action time is 15 min



CAUTION:

- The user must follow the special instructions of the manufacturer of the fully automatic washing machine. In order to ensure the cleaning and disinfection effect, the cleaning and disinfection time should not be less than the time recommended by the manufacturer.
- We recommend the use of proven Lilcon® multi-enzyme cleaning solution or multi-enzyme cleaning solution that complies with local regulations (e.g. CE, FDA approval).
- Please use a washer-disinfector that meets the requirements of ISO 15883.
- Considering that some countries have different requirements for A0 values, please refer to ISO 15883 for temperature and time of disinfection.



CAUTION:

- Have components been sterilized? (Refer to chapter 7)
- Is the battery sufficiently charged? (Refer to chapter 5.1)

2.4 Endo Motor Mode

If not any test wire connected to the instrument, it's in Endo Motor Mode.

Please refer to Fig. C, D

2.4.1 Connect the Components

- Connect contra angle

Line up the projection inside the contra angle with the notch inside the motor and slide it in until it clicks securely into place.

- Connect file

Hold down the push button on the contra angle and insert the file. Turn the file back and force until it is lined up with interior latch groove and slips into place. Release the button to lock the file into the contra angle.

- Connect lighting device (Suitable for LED type)

Insert the lighting device into the instrument and clip the electrode on the file.



WARNING:

- Make sure the connection ends of the motor handpiece and the contra angle is not damaged. If these are damaged, the load on the contra angle could cause the motor to reverse rotation, and this might result in an injury to the oral cavity.
- Files are expendable, and they eventually wear out. Replace them before they break.

- Never use stretched, deformed or damaged files.
- Make sure the file is all the way in. Give the file a light tug to confirm it is securely held in place. If the file is not securely placed, it could come out and injure the patient.



CAUTION:

- Be careful when inserting and removing files to avoid injury to fingers.
- Inserting and removing files without holding the push button may damage the chuck.
- When installing/removing the lighting device, do not shake them at will to avoid damaging the plug.
- Take care not to touch  when installing or removing the file. This will cause the file to rotate.



NOTE:

Hold down the push button on the contra angle and pull the file straight out.

b) After cleaning, remove any liquid residue with a lint-free cotton cloth and then dry with compressed air (1-2 Bar).



WARNING:

Do not put the Lip Hook, File Clip, and Contra Angle Holder into the disinfectant container for immersion and disinfection. If the internal liquid is not cleaned and the drying is not complete, the internal parts will be corroded.

7.4 Manual Disinfection

Place the lint-free cotton cloth in a container filled with LIRCON® medical device cleaning solution (metal type), wring it out and wipe the Test Wire, Lip Hoop, File Clip, Contra Angle Holder/Lighting device and Contra Angle at least 3 times.

It is recommended to use the medical device cleaning solution (metal type) of LIRCON®, which with an effective chlorine content of 1.0%-1.2% (W/V).



WARNING:

Do not put the Test Wire, Lip Hoop, File Clip, Contra Angle Holder/Lighting device and Contra Angle into the disinfectant container for immersion and disinfection. If the internal liquid is not cleaned and the drying is not complete, the internal parts will be corroded.



CAUTION:

If you want to use other disinfectant, use a disinfectant that complies with local national regulations (such as CE certification, FDA certification), and follow the instructions provided by the disinfectant manufacturer.

7. Cleaning, Disinfection and Sterilization

NOTE:

Cleaning, disinfection, and sterilization have limited impact on the reusable part of the instrument. Therefore, the number of times the procedure is repeated is determined by the degree of wear of the part. If visual inspection reveals damaged parts, stop using them and purchase new parts from the manufacturer or dealer.

7.1 Preparation after Using

Immediately after use, the reusable parts should be immersed in tap water <40 ° C (The quality of drinking water, the 'water' mentioned in this chapter, is required to meet this standard.) to remove dirt. Do not use a fixed detergent or warm water (>40 ° C), as this will cause the residue to be fixed and affect the post-treatment effect.

Transportation: Transport to the post-processing area for safe storage to avoid any damage and environmental pollution.

7.2 Preparation before Cleaning

7.2.1 Disassemble the Lip Hook, File Clip and Contra Angle

Holder and place them in a stainless steel box.

7.2.2 Decontamination preparation (Pre-cleaning)

Flush the Lip Hook, File Clip and Contra Angle Holder with running tap water <40 ° C until all visible residue is removed.

7.3 Manual Cleaning

- a) Rinsing the Lip Hook, File Clip and Contra Angle Holder in flowing tap water (<40 ° C)

2.4.2 LCD Display

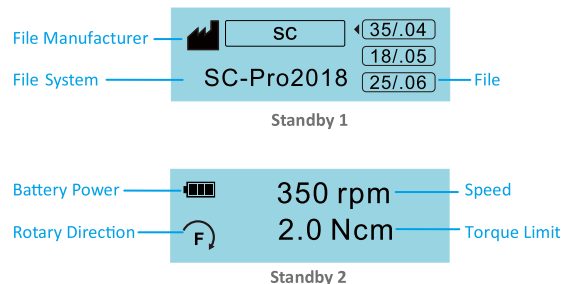

NOTE:

Some files are designed specifically for use in reciprocation. If one of above mentioned reciprocating files has been chosen, the speed and torque display "— —".

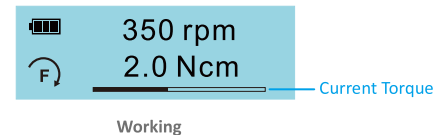
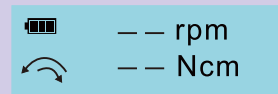

2.4.3 System and File

The instrument contains a file library and preset the parameters based on information provided by the manufacturer.

- a) Hold down **(P)** to enter selection interface and press **(P)** again to select the manufacturer.



NOTE:

The change will be saved automatically. Press **(S)** or **(A)** to exit the selection interface.

- b) Press **(P)** to choose the file system.



- c) Press **(S)** to choose the file.



WARNING:

- Follow the file manufacturer's instructions for use of endodontic files. Do not use files designed for reciprocating motion in Continuous Rotary File Mode.
- The file system shown on the display must always match the file in use.

NOTE:

Press **(S)** again to continue or press any other key to exit.

- c) This will rotate the display direction 180° when **(S)** has been pressed.

6.4 Reset Memories to Original Default Settings

NOTE:

All memories and handpiece settings will revert to their original default settings.

- a) Press **(A)** to choose the reset function.



- b) Press **(S)** to start the reset process.



NOTE:

Press **(S)** again to continue or press any other key to exit.

- c) The reset process is completed.



d) When the calibration process is completed, the rotation stops.



Display shows OK, indicates that the instrument function is normal.

Display shows NG, indicates that there is a fault.

CAUTION:

- NG message indicate that the instrument is not operating properly. Please contact your local dealer or contact the factory directly for assistance.
- Do not touch the file or apply pressure to the motor, otherwise the calibration will fail.

6.3 Set Dominant Hand

This will rotate the display direction 180°.

Set this for right or left depending on the user's dominant hand.

a) Press **(A)** to choose the screen function.



b) Press **(S)** to start the process.



2.4.4 Start Working

a) Start Motor

Press **(M)** to start the motor and press again to stop it.

The lighting device will continue to illuminate while the motor is running.
(Suitable for LED type)

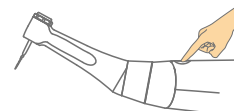

WARNING:

If the contra angle's file release button is pressed against the teeth opposite the one being treated, the file could come out and injure the patient. Before use, run the instrument outside the oral cavity to make sure it is operating normally.

b) Rotary Direction

Press **(A)** to change the direction of file rotation.



NOTE:

The screen is red when the motor rotates in the reverse direction.

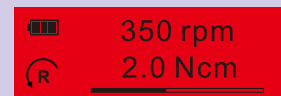

(F) Means forward rotation

(R) Means reverse rotation

2.4.5 Auto Reverse

If, during operation the load reaches the preset torque limit value, the motor handpiece will automatically rotate in the reverse direction. When the load is reduced, the motor handpiece returns to normal forward rotation automatically.

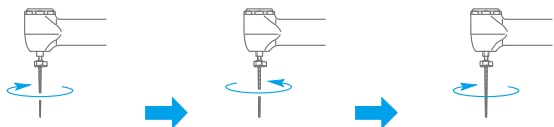

Load within the torque limit value

Load beyond the torque limit value

When the load is reduced, the motor is automatically restored

CAUTION:

Do not apply excessive force. Even when using the torque reverse function, files may break depending on the torque setting.

6. Calibration and Settings

6.1 Enter Setting Mode

a) Hold down **(A)** to enter setting interface.



b) Press **(A)** again to choose the function you need to set.

6.2 Calibration

a) Press **(A)** to choose the calibration function.



b) Press **(S)** to start the calibration process.



NOTE:

Press **(S)** again to continue or press any other key to exit.

c) During the calibration process, the motor handpiece begins to rotate.

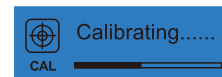

5.3 Replacement Battery

 Please refer to Fig. H

Replace the battery if it seems to be running out of power sooner than it should.

- Turn the power off
- Use tweezers to open the rubber cover and then remove the screw.
- Remove the battery cover as shown in the illustration.
- Remove the old battery and disconnect the connector.
- Connect the new battery and put it in the motor handpiece.
- Install the cover and its screw.

CAUTION:

- Use only battery designed for the instrument. Other batteries could cause overheating.
- Do not use a battery if it is leaking, deformed, discolored or if its label is peeled off. It might overheat.

NOTE:

- Do not leave the power on when disconnecting the battery.
- Open the rubber cover carefully. Don't pull too hard. It might come off the motor handpiece.
- Do not remove the battery cover if the handpiece is wet.
- Do not tighten the cover screw too much. This could strip the threads.
- Dispose of old batteries in an environmentally safe way and in strict according to local regulations.

2.4.6 Change Speed and Torque

CAUTION:

- While the motor handpiece is in motion, speed and torque cannot be changed;
- In a reciprocating rotary file mode, speed and torque cannot be changed.

- Hold down **(S)** until the Speed flash and press **(S)** again to select speed or torque to adjust.



- Press **(A)** to adjust desired value.



- The change will be saved automatically. Press **(P)** to exit the setting, or exit the setting automatically after a few seconds.

NOTE:

When the user changes the default parameter, its value will prompt [].

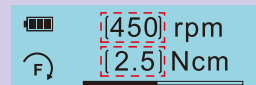

2.4.7 User System

The instrument contains two user-created systems: **Rotary File** and **Recipro File**. Users can set parameters by themselves.

a) Rotary File

There are 5 continuous rotary files in the system and users can change speed and torque. (Refer to 2.4.6)

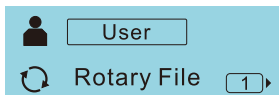

b) Recipro File

There is a reciprocation rotary file in the system and user can change speed and rotation angle.



To change speed and rotation angle, follow the next step:

- a) Hold down **(S)** until the Speed flash and press **(S)** again to select speed or rotation angle to adjust.



- b) Press **(A)** to adjust desired value.



- b) Put the handpiece all the way into the battery charger. The Ready LED (green) will go out and the Charge LED (yellow) will flash and start charging.

- c) When the battery is fully charged, the Charge LED (yellow) goes out and the Ready LED (green) will light up.

⚠ WARNING:

- Do not touch the AC adapter if there is lightning while the battery is being charged. This will result in an electric shock.
- Do not use the battery charger in a place where it might get wet.

⚠ CAUTION:

Do not charge the handpiece with the probe cord connected or wrapped around the handpiece. This could break a wire inside the cord or damage the jack.

👉 NOTE:

- If the Charge LED (yellow) goes off immediately or doesn't light up when the handpiece is put into the charger, the battery is already fully charged. To make sure, take the handpiece out and put it back in again.
- Do not leave the battery charger where it will be exposed to direct sunlight.
- Unplug the battery charger when it is not being used.

5. Battery and Charging

5.1 Battery Power

The number of bars shows how much power is left.



NOTE:

The display of low voltage:

Low Battery



Charge the battery as soon as the indicator gets down to only one bar.

5.2 Battery Charging

 Please refer to Fig. G

- Plug the DC end of the adapter cable all the way into the charger, and plug the other end into a power outlet. The Ready LED (green) will light up.

NOTE:

The battery is inside the motor handpiece.

WARNING:

- Always use the adapter that comes with the instrument. Using another adapter can result in electric shocks, malfunctions, fires, etc.
- The charger and its adapter must be located at least 2 meters away from the patient.
- Do not use the battery charger for any device except the instrument.

2.5 Apex Locator Mode

While the test wire A is connected to the instrument, the instrument enters the Apex Locator Mode automatically. Please refer to Fig. E

2.5.1 Connect the Components

- Connect lip hook and file clip
- Connect file
- Connect test wire A

CAUTION:

- When clipping the file clip onto the metal part of a file or reamer, clip the file clip onto the metal shaft near the handle. Do not clip it onto the cutting part or transition part of the file or reamer. This will cause the file clip to wear out very quickly.
- Do not bang or bump the plugs when they are inserted.
- Make sure the plug is all the way in. Otherwise canal measurements cannot be made.
- Do not wind the probe cord around the instrument.

NOTE:

To measure a root canal, use a file or reamer with a plastic handle. If you do not wear gloves, do not use a file with a metal handle. Current leakage from a metal handle to your fingers will prevent an accurate measurement. Do not use damaged or worn file clip, otherwise accurate measurements cannot be made.

2.5.2 LCD Display

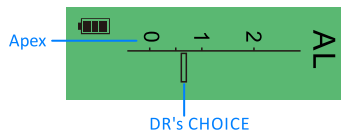

2.5.3 Measurement

a) Hook the lip hook in the corner of the patient's mouth.

⚠ WARNING:

- Never use an electric scalpel when the lip hook is hooked in the patient's mouth. These devices emit electrical noise that could interfere with accurate measurement or cause the instrument to malfunction.
- Make sure that the lip hook, file clip and their connectors do not come into contact with an electric power source such as a power outlet. This will result in an electric shock.
- If connections are not securely plugged in the instrument may not make an accurate measurement. If the meter does not change as the file goes down the canal, stop using the instrument immediately and make sure all the connectors are securely inserted.

⚠ CAUTION:

- The lip hook could cause an adverse reaction if the patient has an allergy to metals. Ask the patient about this before using the lip hook.
- Take care that medicinal solutions such as formalin cresol or sodium hypochlorite do not get on the lip hook or the file clip. These could cause an adverse reaction such as inflammation.

b) Check Test Wire B

Touch the lip hook with the file in the contra angle and check that all the bars on the meter in the display light up.



(Suitable for non-LED type)

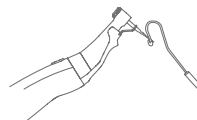

(Suitable for LED type)

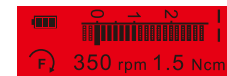

⚠ WARNING:

Check the instrument's function before use with each patient. If all the indicator bars do not light up, an accurate measurement cannot be made. In this case, stop using the instrument immediately and have it repaired.

4. Operation Check

4.1 Check with Tester

- Connect the tester to the test wire jack on the back of the motor handpiece.
- Check that the canal length indicator bars light up between number 0.2 and number 0.5.

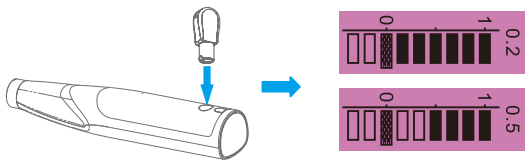

⚠ WARNING:

If the canal length indicator bars does not light up between number 0.2 and number 0.5, an accurate measurement cannot be made. In this case, stop using the instrument immediately and have it repaired.

4.2 Check Canal Measurement Function

- Check Test Wire A

Touch the lip hook with the clip on the end of the file clip and check that all the flash bars on the meter in the LCD display light up.

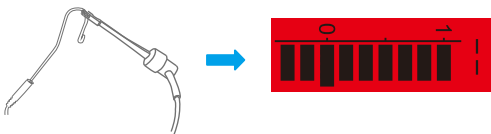

- Slowly insert the measuring file into the canal.

Bar in meter show the location of the file tip. The color of the display:

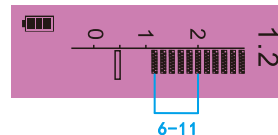

There is slow beeping sound between bars 6-11.

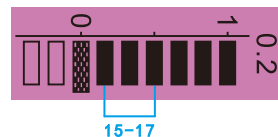

There is fast beeping sound between bars 15-17.

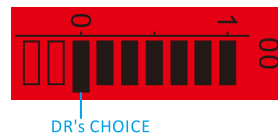

A sustained beep sounds when the file tip reaches or exceeds the DR's CHOICE.



WARNING:

- In some cases such as a blocked root canal, a measurement cannot be made. (Refer to chapter 3)
- Accurate measurement is not always possible, especially in cases of abnormal or unusual root canal morphology. Make sure to take an X-ray to check the results.
- Stop using the instrument immediately if it does not seem to be working properly.
- If the canal length indicator bar does not appear even when the file is inserted, the instrument may be malfunctioning and must not be used.



CAUTION :

- If the canal is too dry, the meter may not move until the file is near the apex. If the meter does not move, stop the measurement. Moisten the canal with oxydol (hydrogen peroxide) or saline, and then try measuring again.
- Occasionally the meter will make a sudden and large movement as soon as the file is inserted into the root canal, but it will return to normal as the file is advanced down towards the apex.
- After measuring the root canal, make sure to take an X-ray to check the measurement results.
- The numerals 1, 2, and 3 do not represent length in millimeters from the apical. These numbers are used to estimate the canal's working length.

A branch canal will also cause electrical leakage.

Re-treatment of a root filled with gutta-percha

The gutta-percha must be completely removed to eliminate its insulating effect. After removing the gutta-percha, pass a small file all the way through the apical foramen and then put a little saline in the canal, but do not let it overflow the canal opening.

Crown or metal prosthesis touching gingival tissue

Accurate measurement cannot be obtained if the file touches a metal prosthesis that is touching gingival tissue. In this case, widen the opening at the top of the crown so that the file will not touch the metal prosthesis before taking a measurement.

Cutting debris on tooth

Pulp inside canal

Thoroughly remove all cutting debris on the tooth.

Thoroughly remove all the pulp inside the canal. Otherwise an accurate measurement cannot be obtained.

Caries touching the gums

In this case, electrical leakage through the caries infected area to the gums will make it impossible to obtain an accurate measurement.

Blocked canal

The meter will not move if the canal is blocked.

Open the canal all the way to the apical constriction to measure it.

Extremely dry canal

If the canal is extremely dry, the meter may not move until it is quite close to the apex. In this case, try moistening the canal with oxydol or saline.

3. EMR (Electric Measurement of Root canal length)

Accurate measurement cannot be obtained with the root canal conditions shown below.

Root canal with a large apical foramen

Root canal that has an exceptionally large apical foramen due to a lesion or incomplete development cannot be accurately measured. The results may show shorter measurement than the actual length.

Root canal with blood overflowing from the opening

If blood overflows from the opening of the root canal and contacts the gums, this will result in electrical leakage and an accurate measurement cannot be obtained. Wait for bleeding to stop completely. Clean the inside and opening of the canal thoroughly to get rid of all blood, and then make a measurement.

Root canal with a chemical solution overflowing from the opening

An accurate measurement cannot be obtained if some chemical solution is overflowing from the canal opening. In this case, clean the canal and its opening. It is important to get rid of any solution overflowing from the opening.

Broken crown

If the crown is broken and a section of the gingival tissue intrudes into the cavity surrounding the canal opening, contact between the gingival tissue and the file will result in electrical leakage and an accurate measurement cannot be obtained. In this case, build up the tooth with a suitable material to insulate the gingival tissue.

Fractured tooth

Leakage through a branch canal

Fractured tooth will cause electrical leakage and an accurate measurement cannot be obtained.

2.5.4 Set the DR's CHOICE

This feature enables to mark an individual predetermined reference position at the required distance from the apex.

When DR's CHOICE apical arrow is set, clear visual and audio indication is given that the file has reached this pre-selected position.

TO set the DR's CHOICE, follow the next step:

Hold down **(S)** until the apex setting icon flash.



Press **(A)** to adjust the apex position.



NOTE:

The apex position set by the user will be saved automatically. Exit the setting automatically after a few second.

2.6 Multi-function Mode

While the test wire B is connected to the instrument, the instrument enters the Multi-function Mode automatically. Please refer to Fig. C, D, F

2.6.1 Connect the Components

- Connect lip hook
- Connect test wire B
- Connect contra angle and file.
- Connect contra angle holder/lighting device

CAUTION:

- Do not bang or bump the plugs when they are inserted.
- Make sure the plug is all the way in. Otherwise canal measurements cannot be made.
- Do not wind the probe cord around the instrument.
- Always clip the electrode on the file when using it. Otherwise, measurements may not be accurate or rotation may not be properly controlled. (It may not be possible to measure a canal if blood or some other liquid overflows the canal or if the canal is completely blocked.)

2.6.2 LCD Display

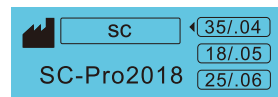

Standby 1

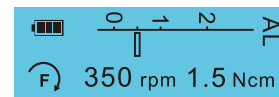

Standby 2

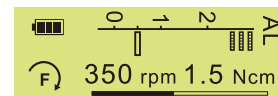

Working

2.6.3 System and File (Refer to chapter 2.4.3)

2.6.4 Start Working (Refer to chapter 2.4.4)

2.6.5 Auto Reverse (Refer to chapter 2.4.5)

2.6.6 Set the DR's CHOICE and Change Speed and Torque

Hold down **(S)** can change the DR's CHOICE, Speed and Torque.

Press **(S)** again to choose the DR's CHOICE, Speed or Torque to change.

a) Set the DR's CHOICE

Press **(A)** to adjust the apex position.



b) Change Speed and Torque (Refer to chapter 2.4.6)